

# EC11-B

## 32" X 18" PLASTIC UTILITY TUB CART

### Product Specifications

Item Number	EC11-B
Material	Injection Molding Thermoplastic Resin Legs: Polyvinyl Chloride (PVC) Shelves: High Density Polyethylene (HDPE)
Color Options	Black, Gray, Blue
Cart Dimensions	35.25" W x 18" D x 34.25" H
Weight	21 lbs.
Shelf Quantity	2
Shelf Dimensions	32" W x 18" D
Shelf Depth	2.5"
Distance Between Shelves	22.5"
Casters (4)	4" full swivel; two casters include locking brakes
Weight Capacity	400 lbs.
Made in USA	Yes
Shipping Carton Dims	1 carton; 36" W x 19" D x 9" H
Shipping Weight	21 lbs.
Assembly Required	Yes

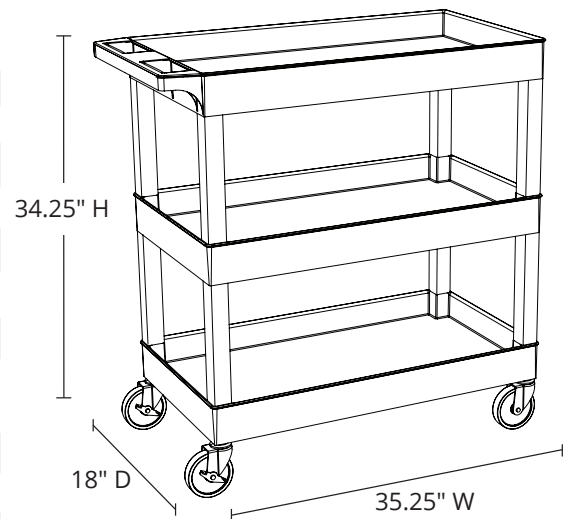

To Order, Call Your  
Sales Representative  
or 800-323-4656